

Model No. 9011C Midi-Torq® Pneumatic Rolling Control

For 3/8" - 3/4" (9.53 - 19.05mm) Tube OD

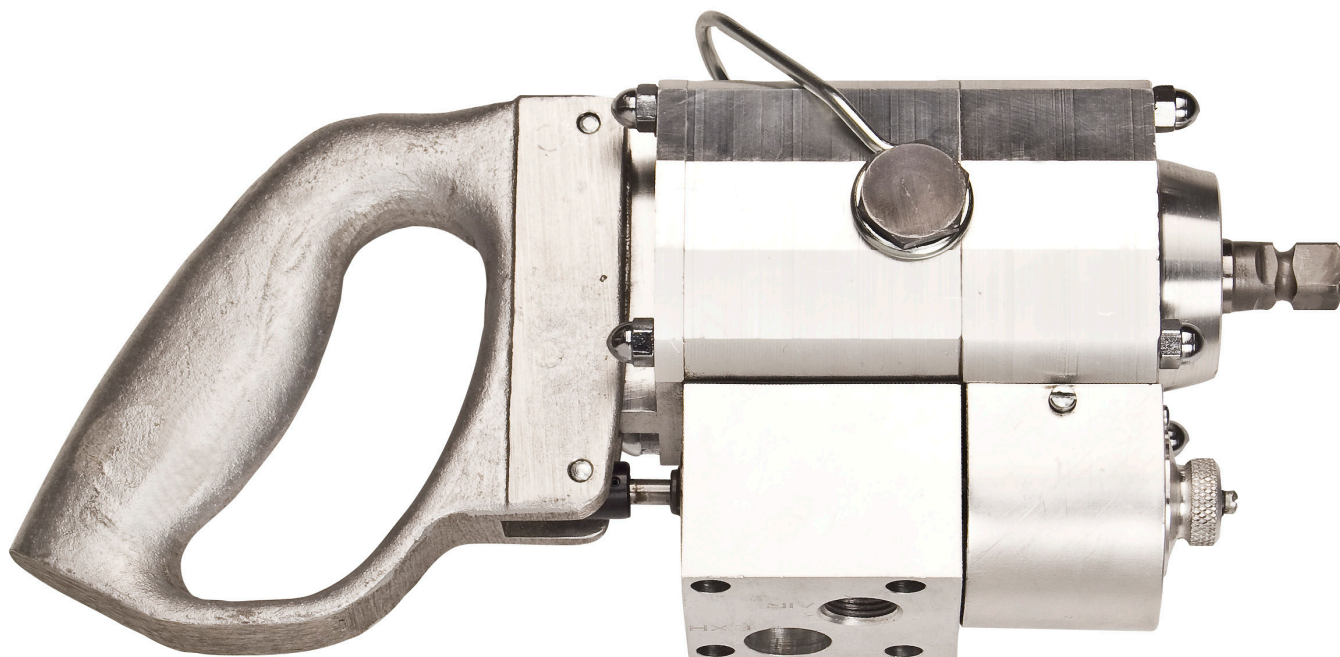

Tube & Pipe Cleaners ◦ Tube Testers ◦ Tube Plugs ◦ Tube Removal ◦ Tube Installation



Operating and Maintenance Instructions

TABLE OF CONTENTS

Introduction	4
Safety	5
Technical Information	7
Set-up & Operating Instructions.....	9
9011C Midi-Torq® Control.....	11
Recommended Tube Expansions	12
Basic Principles of Tube Expanding.....	13
Paddle Replacement Procedure	17
Troubleshooting Guide	19
Parts & Diagrams.....	20
Warranty	22

INTRODUCTION

Thank you for purchasing this Elliott product. More than 100 years of experience have been employed in the design and manufacture of this control, representing the highest standard of quality, value and durability. Elliott tools have proven themselves in thousands of hours of trouble free field operation.

If this is your first Elliott purchase, welcome to our company; our products are our ambassadors. If this is a repeat purchase, you can rest assured that the same value you have received in the past will continue with all of your purchases, now and in the future.

The Elliott Model 9011C Midi-Torq® Pneumatic Rolling Control has been designed for expanding tubes in the following types of equipment:

Heat Exchangers

Condensers

Chillers

Evaporators

Air Conditioners

If you have any questions regarding this product, manual or operating instructions, please call Elliott at +1 800 332 0447 toll free (USA only) or +1 937 253 6133, or fax us at +1 937 253 9189 for immediate service.

SAFETY RECOMMENDATIONS

For your safety and the safety of others, read and understand the safety recommendation and operating instructions before operating.

ALWAYS WEAR PROTECTIVE EQUIPMENT



For additional information on eye and face protection, refer to Federal OSHA Regulations, 29 Code of Federal Regulations, Section 1910.133., Eye and Face Protection and American National Standards Institute, ANSI A87.1, Occupational and Educational Eye and Face Protection. Z87.1 is available from the American National Standards Institute, Inc., 1430 Broadway, New York, NY 10018.



Hearing protectors are required in high noise areas, 85 dba or greater. The operation of other tools and equipment in the area substantially contribute to, and increase the noise level in the area. For additional information on hearing protection, refer to Federal OSHA Regulations, 29 Code of Federal Regulations, Section 1910.95, Occupational Noise Exposure, and American National Standards Institute, ANSI S12.6 Hearing Protectors.

These tools are designed to operate on 90 psi (6.2 bar) maximum air pressure. If the tool is properly sized and applied, higher air pressure is unnecessary. Excessive air pressure increases the loads and stresses on the tool parts, sockets, and fasteners and may result in breakage. Installation of a filter-regulator-lubricator in the air supply line ahead of the tool is recommended.

Continued On Page 6

SAFETY RECOMMENDATIONS

Before the tool is connected to the air supply, check the throttle for proper operation (i.e. throttle moves freely and returns to closed position.) Clear the air hose of accumulated dust and moisture. Be careful not to endanger adjacent personnel. Before removing a tool from service or changing sockets, make sure the air line is shut off and drained of air. This will prevent the tool from operating if the throttle is accidentally engaged.

It is essential for safe operation that any operator of a rolling motor use good balance, sure footing, and proper posture in anticipation of a torque reaction. Ensure that the operator's hand will not be wedged or pinched between the work and the tool when operation.

Caution

Tools with clutches can stall rather than shut-off if adjusted over maximum power of output of tool, or if there is a drop in air pressure. Operator must then resist stall torque until throttle is released.

 WARNING
Repetitive work motions and/or vibrations can injure hands and arms. Use minimum hand grip force consistent with proper control and safe operation. Keep body and hands warm and dry. Avoid anything that inhibits blood circulation. Avoid continuous vibration exposure. Keep wrists straight. Avoid repeated bending of wrists and hands.

Some individuals are susceptible to disorders of the hands and arms when exposed to tasks which involve highly repetitive motions and/or vibration. Those individuals predisposed to vasculatory or circulatory problems may be particularly susceptible. Cumulative trauma disorders such as carpal tunnel syndrome and tendonitis can be caused or aggravated by repetitions, forceful exertions of the hands and arms. These disorders develop gradually over periods of weeks, months, and years.

- Tasks should be performed in such a manner that the wrists are maintained in a neutral position which is not flexed, hyperextended, or turned side to side.
- Stressful postures should be avoided and can be controlled through tool selection and work location.

Any user suffering from prolonged symptoms of tingling, numbness, blanching of fingers, clumsiness or weakened grip, nocturnal pain in the hand, or any other disorder of the shoulders, arms, wrists, or fingers is advised to consult with a physician. If it is determined that the symptoms are job related

Continued On Page 7

SAFETY RECOMMENDATIONS

or aggravated by movements and postures dictated by the job design it may be necessary for the employer to take steps to prevent future occurrences. These steps might include, but are not limited to, repositioning the workpiece or redesigning the workstation, reassigning workers to other jobs, rotating jobs, altering work pace, and/or changing the type of tool used so as to minimize stress on the operator. Some tasks may require more than one type of tool to obtain the optimum operator/tool/task relationship.

The following recommendations will help reduce or moderate the effects of repetitive work motions and/or extended vibration exposure.

- Use a minimum hand grip force consistent with proper control and safe operation.
- Keep wrists as straight as possible.
- Keep body and hands warm and dry.
- Avoid anything that inhibits blood circulation (smoking tobacco, cold temperatures, certain drugs, etc.)
- Avoid highly repetitive movements of hands and wrists, and continuous vibration exposure.

TECHNICAL INFORMATION

Operating Pressure

90 psi (6.2 Bar)

Air Consumption

45 cfm (368 L/min.)

Motor Free Speed

1,800 RPM

Lubrication

Use light machine oil

Motor Weight

8 lb. (3.6 Kg.)

Torque Range

15 – 85 in-lb. (1.7 – 9.6Nm)

Spindle Drive

1/2" (12.7mm) Male Square

Drive Size

3/8" (9.53mm) Sq. Quick-Release Chuck

Tube OD Range

3/8" - 3/4" (9.53 - 19.05mm)

9011C Midi-Torq® Kit Contents	
Part Number	Description
901100C	Midi-Torq® Control
901053P	On-Off Valve
901054P	Muffler Unit
901055	Exhaust Hose Assembly
901178P	Hose Adapter
858400-3/8	Quick Release Chuck- 3/8"
8647D	1/4" to 3/8" Square Drive Adapter
P5224-12	7 1/2 ft (2.3M) Air Hose Whip
901717P	Filter-Lubricator
900082P	16 oz. (0.47L) Lube Oil (Grade 10W/NR)
153G	Carrying Box
901187	Side Handle

SET-UP AND OPERATING INSTRUCTIONS

Assembly

Connect the Exhaust Hose Assembly to the base of the valve block and secure into place by tightening the set screw in the valve block. To further reduce the noise level, attach the Muffler Unit to the other end of the Exhaust Hose Assembly. Install the on-off valve into the valve block of the control and install the hose adapter into the on-off valve. Before attaching the air hose to the hose adapter, the air hose should be blown out to eliminate dirt in the hose.

All fittings that require threaded assembly, teflon tape, or equivalent, is required to guarantee the control to be free of air leakage.

Attach the expander to the control by inserting the square of the mandrel into the chuck. Pull the chuck ring toward the expander to allow the squares to mate securely.

Air Pressure

Air pressure is to be 90 psi (6.2 bar) minimum or 125 psi (8.6 bar) maximum. Air pressure under suggested minimum will result in slower rolling cycle. Air pressure at recommended maximum, or above, will result in normal or faster rolling cycle.

Note that air pressure has no effect on torque control sensing since it is independent of the motor section.

Lubrication

Elliott Filter-Lubricator 901717P is recommended for use with the control and should be located within 15 ft. (4.6 M) of the control. Non-fluid oil (grade 10W/NR), such as Elliott lubricant 900082P, made expressly for use with pneumatic motors is recommended. Lubricator should be set to allow 5 to 10 drops of oil per minute. Or, adjust the lubricator with control running full open until a barely noticeable mist comes out of the exhaust hose.

Caution: Do not over lubricate the control. Excessive grease applied to the gear section will cause sluggish operation and premature motor wear.

Note: In field operations, outside of shop environment, if standard type of filter-lubricator is not available, we suggest an Elliott-supplied Arnold type lubricator be added to the air hose line to ensure proper lubrication of the control.

Torque Adjustment

Torque is adjusted with the on-off valve in the off position. Loosen the knob lock screw located in the center of the Torque Set Knob. Turn the knob to the desired setting and retighten the Knob Lock Screw.

SET-UP AND OPERATING INSTRUCTIONS

To determine the required torque setting, start with the setting in the zero position. With the expander full forward on the mandrel, insert the expander into the tube until the collar is against the tube sheet. Push forward on the control handle to start the rolling cycle. When the rolling action stops, pull back on the control handle to reverse the expander rotation. Check for tube tightness in the customary manner. Increase the torque setting and repeat as required to achieve proper tightness. (Note: Numbers on the dial do not represent actual inch-pounds of torque, but are for reference only!)

Rolling Operation

Calculate rolling parameters using tube O.D., wall thickness, tube sheet hole clearance, along with tube material. Tube material will determine percent (%) of wall reduction for optimum expansion. These calculations may be done on the blank chart (Fig. 2) supplied in this tech. manual.

Tubes must not be permitted to rotate during the expansion process. They can be held by a convenient means. Keep the air hoses free of kinks which may restrict the flow of air and may reduce the power of the control. Keep the expander clean and well lubricated. DO NOT operate the expander in a dry condition, or when loaded with dirt or caked grease. Elliott tube rolling lubricant is recommended.

Insert the expander into the tube and start the rolling cycle by pushing forward on the control handle. Hold the handle in this position until the torque control automatically shuts off the motor. The tube should be properly rolled, if the torque adjustment setup procedure has been followed. Retraction of the expander is done by pulling fully back on the control handle and hold in this position until the expander is fully extracted from the tube. When the control handle is released, it will return to the "neutral" position and reset the torque mechanism, ready for the next tube to be rolled. (Note: It is not necessary to shut the motor off between re-positioning of the expander into the next tube.)

(Note: Always shut the control off with the on-off valve when it is not in immediate use or when making an adjustment.)

Caution: Pivot of the control handle must be kept clean, as dirt in this area will "freeze" the handle, resulting in failure of operation.

9011C MIDI-TORQ[®] CONTROL

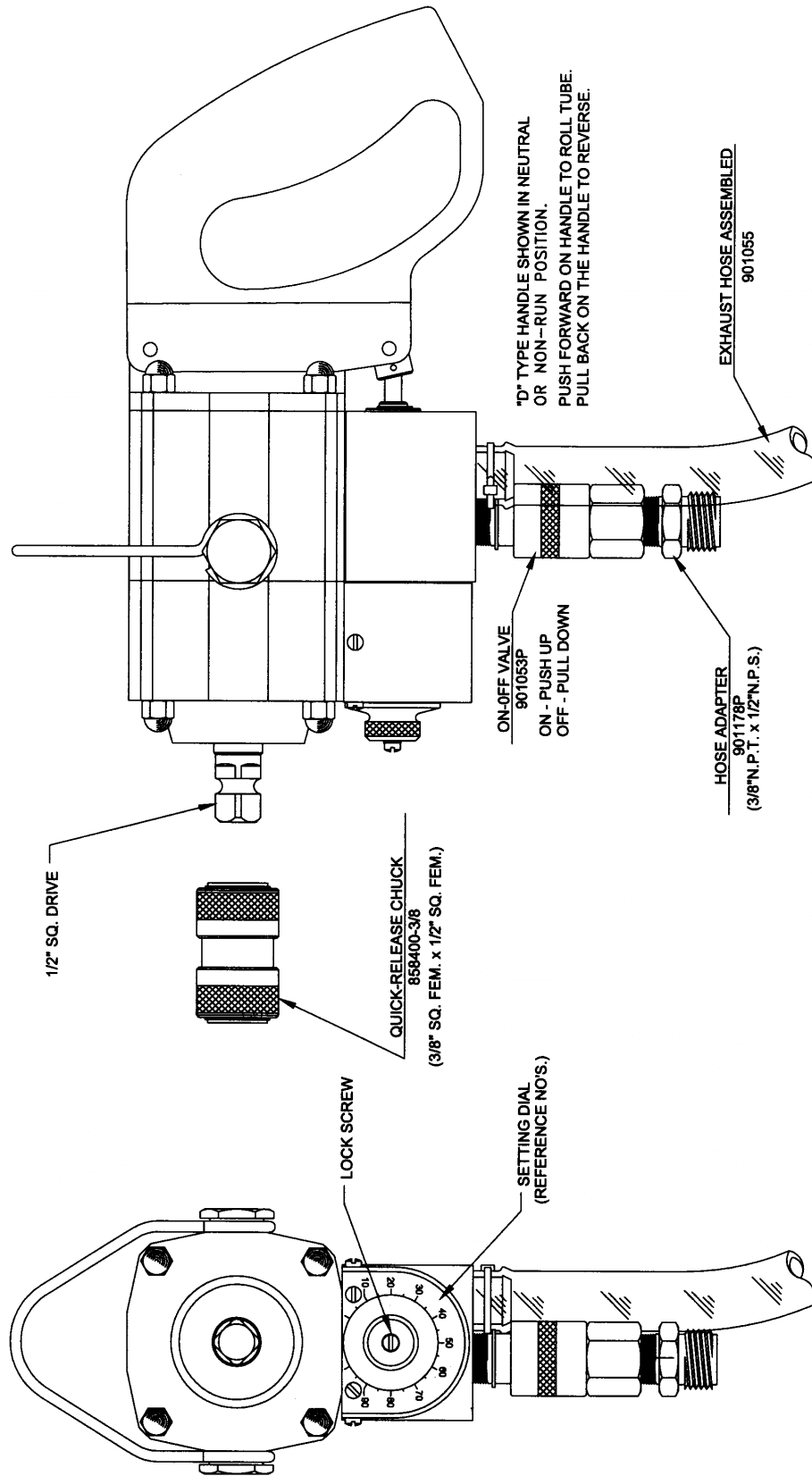

Fig. 1

RECOMMENDED EXPANSION OF TUBES

Use expansion listed in tube expansion column plus clearance between the tube OD and sheet hole ID.
Recommended expansion may be plus or minus .001”.

OD Size	GA	Tube Expansion	OD Size	GA	Tube Expansion	OD Size	GA.	Tube Expansion
½”	14	.006”	¾”	12	.008”	1 ¼”	8	.010”
½”	15	.006”	¾”	13	.008”	1 ¼”	10	.010”
½”	16	.006”	¾”	14	.008”	1 ¼”	12	.009”
½”	17	.005”	¾”	15	.007”	1 ¼”	14	.008”
½”	18	.005”	¾”	16	.006”	1 ¼”	16	.007”
½”	19	.004”	¾”	17	.005”	1 ¼”	18	.006”
½”	20	.004”	¾”	18	.005”			
½”	21	.004”	¾”	19	.005”	1 ½”	8	.012”
			¾”	20	.005”	1 ½”	10	.012”
5/8”	12	.006”	¾”	21	.004”	1 ½”	12	.010”
5/8”	13	.006”				1 ½”	14	.010”
5/8”	14	.006”	1”	8	.009”	1 ½”	16	.008”
5/8”	15	.006”	1”	9	.009”	1 ½”	18	.008”
5/8”	16	.006”	1”	10	.009”			
5/8”	17	.005”	1”	12	.009”	2”	8	.012”
5/8”	18	.005”	1”	13	.008”	2”	10	.012”
5/8”	19	.004”	1”	14	.008”	2”	12	.011”
5/8”	20	.004”	1”	15	.007”	2”	14	.010”
5/8”	21	.004”	1”	16	.006	2”	16	.008”
			1”	17	.005”	2”	18	.008
¾”	10	.008”	1”	18	.005”			
¾”	11	.008”						

Additional Sizes

¼” OD tubes- expand all gauges 0.003” after contact with tube sheet hole.
3/8” OD tubes- expand all gauges 0.004” after contact with tube sheet hole.

Example

¾” OD x 14 gauge tubes

Recommended expansion.....	.008”
Tube sheet hole.....	.760”
Therefore, expand as follows:	
Tube ID before expanding.....	.584”
Recommended expansion.....	.008”
Clearance between tube & tube sheet hole.....	.010”
Finished ID	.602”

The above recommendation is based on our experience. However, this does not constitute a guarantee because of the great variety of materials, tubes and tube sheets used. Some conditions will require experimental rolling to be certain that the rolled joints will be satisfactory.

BASIC PRINCIPLES OF TUBE EXPANDING

Tube expanding is the art of reducing a tube wall by compressing the OD of the tube against a fixed container, such as, rolling tubes into tube sheets, drums, ferrules, or flanges. To assure a proper tube joint, the tube wall must be reduced by a predetermined percentage. The following chart can be used for determining the correct tube wall reduction.

This list shows a typical 3/4" - 16 gauge tube. Before rolling this tube you would find the proper rolling dimension as shown.

1. First determine the tube hole size.
2. Then determine the tube outside diameter.
3. Subtract the tube outside diameter from the tube hole dimension.
4. With an Elliott Tube Gauge, determine the inside diameter of the tube before rolling.
5. By adding the dimension found in "4" to the clearance between the tube OD and the tube hole, you will then know the tube's inside diameter at metal to metal contact.
6. Roll the tube to what you feel is a good tube joint. This example was rolled and then the ID of the tube was checked with an Elliott Tube Gauge.
7. By subtracting "5" from the rolled diameter you determine the actual amount of expansion (tube wall reduction) on the inside diameter of your tube.
8. This can be converted to a % of wall reduction by dividing the actual wall thickness ("2 minus 4") 0.130" into the amount of roll 0.009 as shown in "7" above.

You can use this list to your advantage by predetermining both the % of wall reduction required and the actual inside diameter which should be rolled. After the completion of "5" you realize any additional increase of the inside diameter of the tube will result in actual wall reduction. Since the amount of wall reduction greatly determines the quality of the tube joint, you should arrive at the % required for your application prior to tube rolling.

By subtracting the tube inside diameter "4" from "2", you determine actual wall thickness. This example would therefore be 0.130". If you then take the 7% wall reduction times the wall thickness, you arrive at 0.0091" ("7") to 0.627" ("5") we get "6" the inside diameter of the tube after rolling (0.636").

Continued On Next Page

BASIC PRINCIPLES OF TUBE EXPANDING

This technique is an excellent way to set torque rolling devices. Once you have arrived at the rolled dimension for four or five tubes, you can roll them and very simply determine if more or less wall reduction is required. Knowing how to determine wall reduction is important; however, it is equally important to know the characteristics of the popular tubing materials. We should know the proper wall reduction which would apply to each metal. A simple rule of thumb is the harder the material, the less wall reduction is required to obtain a tube joint. For example, you can assign these as approximate percentages of wall reduction when rolling pressure vessels:

Tubing Material

Copper & Cupro Nickel	8-10%
Steel, Carbo Steel & Admiralty Brass	7-8%
Stainless Steel & Titanium	4-5%

These materials and percentages can be your guide line to rolling tubes of like materials.

Here is a summary of important factors in rolling certain alloys: When rolling 3003 or 4004 Aluminum you should not reduce the walls over 5%. When rolling 6061-T Aluminum, which is one of the most popular materials used in aircraft fittings, you can reduce the wall 10 to 12% for a mechanical joint.

There is a tube process called Alonizing. It is stated that Alonized steel combines the heat and corrosion resistant properties of the iron aluminum alloy with the strength and rigidity of the steel. When rolling this tubing it is extremely important to lubricate each tube end and make certain that the tube expanders are kept clean. Remove all particles of the tubing materials from the expanders to decrease tool fatigue. When rolling Alonized tubing, abrasive particles are removed from the inside diameter of the tubing and gathered in the expander. It is recommended that two expanders be used. One should be cleaned and lubricated while the other is being used.

Admiralty Brass is widely used in condensers. This material should be well lubricated. The tube wall reduced approximately 7% to 8% for optimum tube joints. In general only a 4% to 10% reduction in wall thickness is necessary to produce a tight tube in a serrated hole. On the other hand, reduction in excess of 15% may cause leaking, splits, or flaked tubes.

Carbon Steel is used in almost every type of pressure vessel built today. Tube wall reduction should be approximately 7% to 8%. Heavy lubrication is a must. If the tube is cracking or tooling shows excessive wear, tube hardness should be checked. Carbon Steel tubes should be 90 to 120 Brinnel hardness for rolling. It is possible to roll tubes up to 150 Brinnel; however, flaking and cracking are more likely to occur as the tube hardness increases.

When rolling Copper and Cupro Nickel, consider approximately 8-10% wall reduction to be a proper tube joint. Copper, since it is one of the softer tubes used in pressure vessels, can be easily rolled. Use plenty of lubrication because copper has an abrasive action on tube expanders.

Continued On Next Page

BASIC PRINCIPLES OF TUBE EXPANDING

When rolling Stainless Steel and Titanium, approximately 4 to 5% wall reduction is sufficient to produce a tight tube in a serrated hole. When rolling these alloys the entire wall reduction should be done quickly. These materials have a greater tendency to work harden; therefore, minimal or no rerolling should be done.

When rolling Titanium, it is recommended to use an expander with four rolls or more. This will decrease diaphragm of a thin wall and help eliminate tube end cracking. There are however, exceptions to the above rule.

This discussion of alloys has been related to those used in pressure vessels such as boilers, heat exchangers, and condensers. These factors would be approximately the same in a mechanical joint for industrial use. However, a greater percent of wall reduction is usually considered when making a mechanical joint. Higher quality tubes are used in industrial applications.

Major Causes Of Tube Leaks

Tube rolling leakage is usually caused by one of the following: under-rolling, over-rolling, improper preparation of tube sheets and differential thermal expansion can lead to serious difficulties for both the manufacturer and the repair service men.

Under-Rolling:

Under-rolling is when the tube is not expanded to fill the tube sheet hole and the proper amount of wall reduction is not obtained. It is better to under-roll than to over-roll.

Over-Rolling:

Over-rolling is when the expansion of the inside diameter of the tube surpasses the expansion required for the proper percentage of wall reduction for the ultimate tube joint. Over-rolling will decrease the dimensions of the ligament between tubes and weaken this bridge. Once a ligament is weakened it will cause a reaction in all ligaments surrounding that ligament. If we decrease the strength of the ligament the tube next to the tube being rolled will leak.

Over-rolling also causes distortion in tube sheets or drums, such as egg-shaped holes. It will also cause diametrical expansion which is the overall increase of a tube sheet or drum. Over-rolling has been known to cause a tube sheet to bow or warp to the point where the standard length tube could not be used in the vessel until the bowing or warpage is returned to normal. This is usually corrected by placing stay rods in the vessel and pulling the tube sheets back to their original position.

Improper Preparation Of Tube Holes:

Improper preparation of tube holes is another major cause in tube leakage. If the tube sheet or drum is gouged, it is extremely hard to expand the tube to fill these gouges or tears without over-rolling. The smoother the tube seat or tube hole the easier it is to roll an optimum tube joint. The ligaments and light tube walls make it more important that the finish of the tube hole be in the low micro range. We find many manufacturers today are drilling, reaming and sizing or burnishing to get the microfinish desired for tube holes.

Continued On Next Page

BASIC PRINCIPLES OF TUBE EXPANDING

Differential Thermal Expansion:

Differential thermal expansion can result with thicker tube sheets. When the expansion due to heat varies noticeably between the thinner tube and tube sheet, a shift of the tube results. One of the most important steps for guaranteeing a safe and permanent tube joint is to thoroughly clean the surfaces of the tube end and the tube hole wall. These two surfaces must be clean and free of all dust, mill scale and pits or scratches. It is extremely important to eliminate any longitudinal cracks in the tube hole wall. These longitudinal lines will cause leaky tubes.

Preparation of Tube Holes

Preparation of tube holes in heat exchangers and condensers is as follows:

1. Drill and ream tube sheet holes to 0.007" to 0.010" over the outside diameter of the tube to be used.
2. Be certain the ligaments are sufficient to guarantee a safe and permanent tube joint.
3. When conditions permit, utilize a sizing or burnishing tool to further assure a good finish in the tube hole. This will also increase the tensile strength of the ligament.
4. The serrations or grooves to be used will determine the holding power of the tube.
5. It is extremely important when retubing that the grooves be cleared of all metals or any foreign material.

Preparation of Tube Seats

Preparation of tube seats in drums, tube sheets, and headers are as follows:

1. Tube holes are normally drilled and reamed to approximately 1/32" larger than the nominal outside diameter of the tubes.
2. It is extremely important during this operation that there are no longitudinal cracks left in the tube seat.
3. In cases where out-of-roundness is extreme, pre-rolling of the tube holes is advised.
4. Be certain that the tube hole walls and the grooves in the tube walls are cleaned down to bare metal before tubes are inserted. Be certain all foreign material such as oil, grease, rust, or just plain dirt are removed. Special attention during this cleaning will prevent serious trouble later.

After tube holes have been properly prepared they are usually coated with a rust preventative compound. Before inserting any tube it is important to remove all traces of this coating. It is extremely important that great care be taken in handling the tubes for insertion in all of the vessels discussed above. Be certain that the tube ends are clear of any foreign material. Be especially certain that there are no chips on the tubing which may gouge the tube sheet or tube seat when the tube alignment will prevent future troubles.

PADDLE REPLACEMENT PROCEDURE

Before performing any maintenance function on the Rolling Motor be sure to remove the air supply by physically disconnecting the air supply hose from the motor.

Position the motor on a table top or flat working area. Remove the Hanger "33" and Hanger Nuts "34" from the motor.

Tear off 3 pieces of Masking Tape and place them on the motor just in front of the Rear Cover "20" running down the side of the motor where the Hanger Nuts were located progressing up to the Square Drive of the Spindle Cage "9". Place the Masking tape on both sides and top of the motor where the Hanger was located.

Remove the Hinge Pin "19" from the D-Handle "27" by driving it out with a punch correctly sized just under the Hinge Pin diameter of 3/16" or .187" in diameter. Take care to support the D-Handle from the underside when performing this pin removal.

With the Masking Tape in place using a 3/8" wrench, remove the four Acorn Nuts "28" on the back of the motor where the D-Handle "27" is located. These Acorn Nuts are attached to Body Bolts "29" which run the length of the motor. The Masking Tape will keep the motor body sections together during the Paddle replacement process.

Remove the D-Handle and Rear Cover assembly. Remove the End Plate Assembly "4" from the Rotor "2". Special care must be taken to insure the Rotor Washer "5" is on the Rotor or in the End Plate when the End Plate is removed.

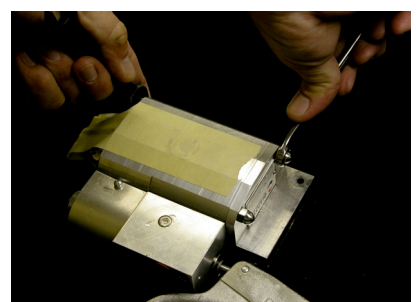
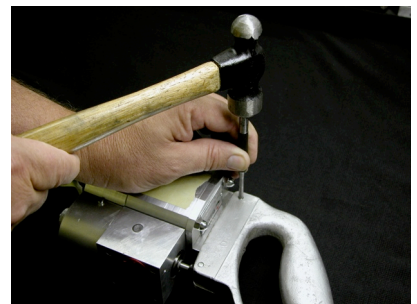
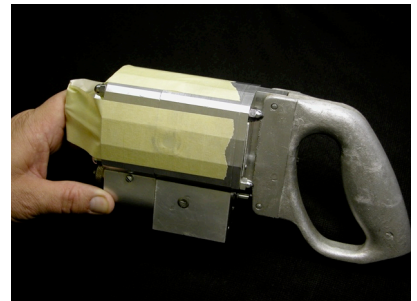
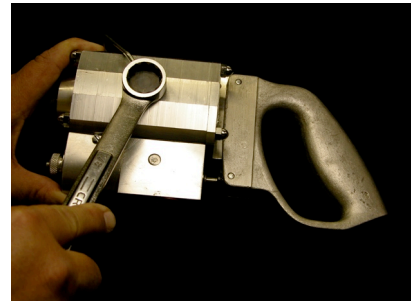

PADDLE REPLACEMENT PROCEDURE

The Rotor can now be removed from the motor. Take care to keep the old Paddles in place within the Rotor cavities until extraction is complete.

With the Rotor in hand, remove the old Paddles “3”.

The new Paddles must now be coated with a light application of non-fluid oil (grade 10W/NR), such as Elliott Lubricant 900082P before being inserted into the Rotor. Please note, the Paddles must be positioned within the Rotor with the Chamfered ends toward the center of the Rotor. See figure 1.

The reassembly of the motor can now be made in reverse order to instructions above.

NOTE: Do not over tighten the Acorn Nuts during final assembly. 75 Inch Pounds of torque MAXIMUM.

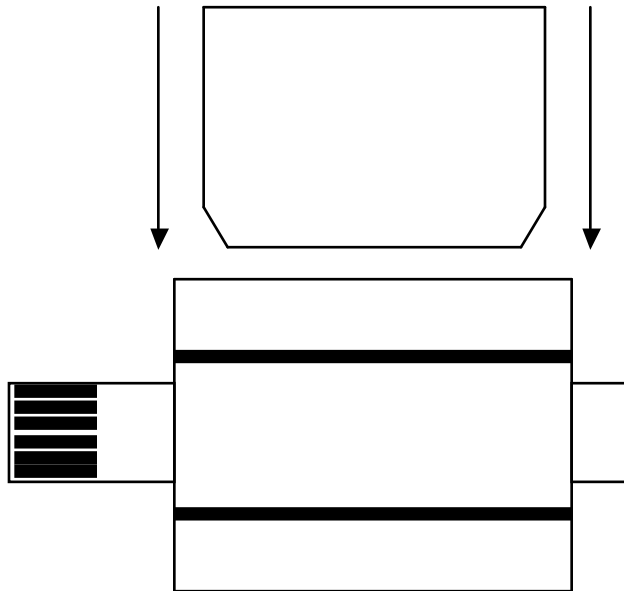

Figure 1

TROUBLESHOOTING

	Air Leakage	Air Strainers Clogged	Air Pressure Too Low	Dirty Air	Water In Air	Incorrect Lubrication	Insufficient Lubrication	Hose Too Small	Long Paddles	Worn Paddles	Rotor Rubbing	Worn Beaning Plates	Worn Valve Seat
Motor Will Not Run		X	X				X		X		X		
Lack Of Power	X	X	X			X		X		X	X	X	
Speed Too Low		X	X					X			X		
High Air Consumption	X									X		X	
Excessive Paddle Wear				X		X	X						
Excessive Bearing Wear				X		X	X						
Rusting Of Parts					X	X	X						
Delamination Of Paddles				X	X	X							
Paddles Chipping				X		X	X						
Motor Continues To Run, Throttle Off													X

Pneumatic Motors have assemblies built to very close tolerances. Under constant use and with the possibility of foreign parts moving through the air line, these tolerances have a tendency to suffer. Air motor maintenance is critical. Dirt should not be allowed to collect around exhaust ports or fitting connections.

PARTS & DIAGRAMS

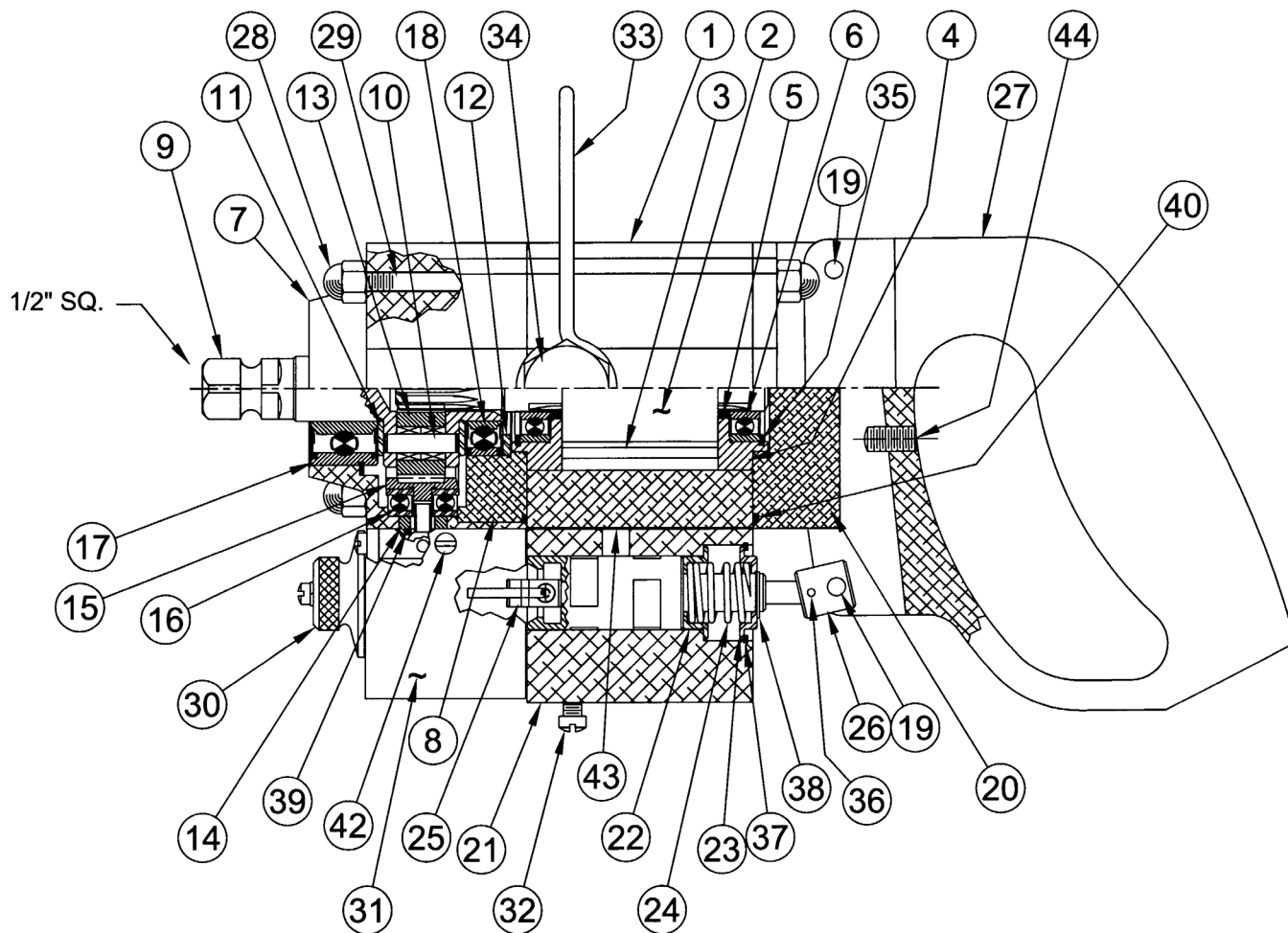

PARTS & DIAGRAMS

Item #	Part Name	Part Number
1	Body Assembled	901101
2	Rotor	901005
3	Paddle Set	901008P-5
4	End Plate	901010
5	Rotor Spacer	901007
6	Bearing	901011P
7	Gear Case	901114
8	Center Plate	901015
9	Spindle Cage	901016C
10	Needle Roller	901017P
11	Cage Washer	901018
12	Spacer Washer	901019
13	Planet Gear w/Bearing	901020
14	Dowel Ring	901122
15	Ring Gear	901023
16	Bearing (Ring Gear)	901024P
17	Bearing (Front)	901025P
18	Bearing (Rear)	901026P
19	Hinge Pin	901127
20	Rear Cover	901130
21	Valve Block & Stem Assembly	901137A
22	Spring Cup	901140
23	Spring Stop	901141
24	Valve Spring	901142P
25	Trip Stem Assembly	901143A
26	Toggle Block	901145
27	D-Handle	901132
28	Acorn Nut	901060P

Item #	Part Name	Part Number
29	Body Bolt	901050
30	Torque Sensor Assembly	901160B
31	Cover Plate	901175P
32	Fil. Hd. Mach. Screw	P8324-12
33	Hanger	901185P
34	Hanger Nut	901186
35	Retaining Spring (End Plate)	P8587-106
36	Spring Dowel Pin	P8380-7
37	Retaining Ring (Valve Block)	P8368-100
38	Retaining Ring (Valve Stem)	P8375-39
39	O-Ring (Dowel Ring)	P8309-5
40	O-Ring (Motor Body)	P8309-38
41	Fil. Hd. Mach. Screw (not shown)	P8324-4
42	Fil. Hd. Mach. Screw	900071P
43	Gasket	901134P
44	Oval Point Set Screw	901181
45	Side Handle (Not Pictured)	901187

WARRANTY

Should any part, of Seller's own manufacture, prove to have been defective in material or workmanship when shipped (as determined by Seller), Seller warrants that it will, at its sole option, repair or replace said part f.o.b., point of manufacture, provided that Buyer notifies, in writing, of such defect within twelve (12) months from date of shipment from the manufacturing plant.

On request of Seller, the part claimed to be defective will be returned, transportation, insurance, taxes and duties prepaid, to the factory where made, for inspection. Any item, which has been purchased by Seller, is warranted only to the extent of the original manufacturer's warranty to Seller. Seller shall not be liable for any damages or delays caused by defective material or workmanship.

No allowance will be made for repairs or alterations made by others without Seller's written consent or approval. If repairs or alterations are attempted without Seller's consent, Seller's warranty is void.

THE WARRANTIES PROVIDED IN THE OBLIGATIONS AND LIABILITIES OF SELLER HEREUNDER, AND THE RIGHTS AND REMEDIES OF BUYER HEREUNDER ARE EXCLUSIVE AND IN SUBSTITUTION FOR, AND BUYER HEREBY WAIVES ALL OTHER WARRANTIES, GUARANTEES, OBLIGATIONS, CLAIMS FOR LIABILITIES, RIGHTS AND REMEDIES, EXPRESS OR IMPLIED, ARISING BY LAW OR OTHERWISE, INCLUDING BUT NOT LIMITED TO THE IMPLIED WARRANTY FOR MERCHANTABILITY AND FITNESS FOR PURPOSE.

Seller's total liability is limited to the lower of the cost of repair or replacement.

Page Intentionally Left Blank



Contact Us

Elliott Tool offers a complete line of precision tube tools to meet your needs. Contact us or your local support.

Elliott Tool Technologies, Ltd.
1760 Tuttle Avenue
Dayton, Ohio 45403-3428
Phone: +1 937 253 6133 • +1 800 332 0447
Fax: +1 937 253 9189
www.elliott-tool.com

Printed in the USA
©09/2017 Elliott Tool Technologies, Ltd.
TM-98
PL-33

Locally Supported By:

www.elliott-tool.com/support